



8-1/2 x 11 Pressure Sensitive Laser Sheets



Back Slit

1 Label - 8.5 x 11

*Compatible with Avery® #5165

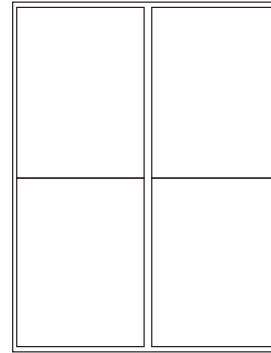

Label Size - 4 x 5

*Compatible with Avery® #6828

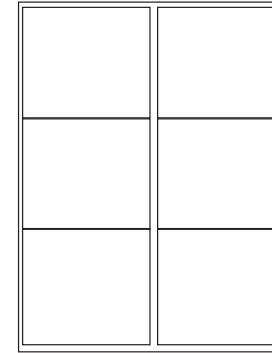

Label Size - 4 x 3-1/3

*Compatible with Avery® #5164

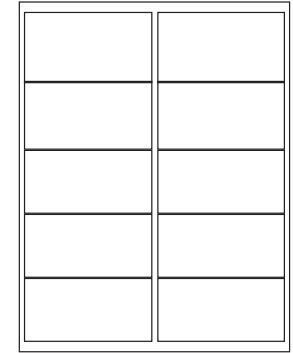

Label Size - 4 x 2

*Compatible with Avery® #5163

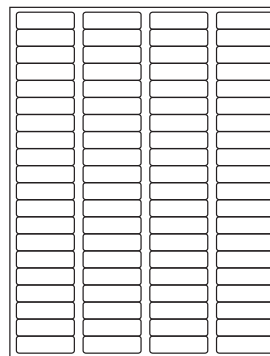

Label Size - 1-3/4 x 1/2
Return address labels

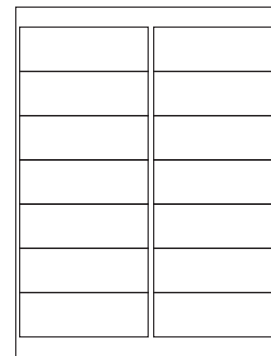

Label Size - 4 x 1-1/3

*Compatible with Avery® #5162

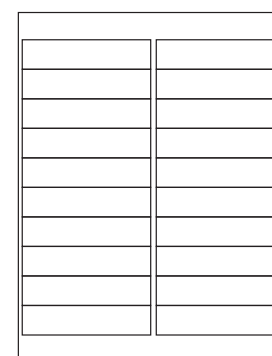

Label Size - 4 x 1

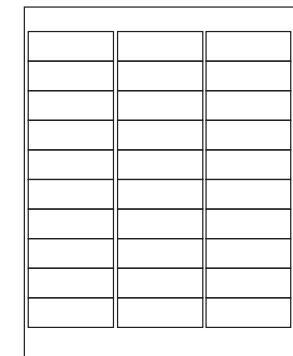

Label Size - 2-5/8 x 1

*Compatible with Avery® #5160

Ink Jet And Laser Compatible

50# Matte Text

50# Stay Flat Liner

1000 Per Carton

Please Call For Test Samples - 877-591-9768

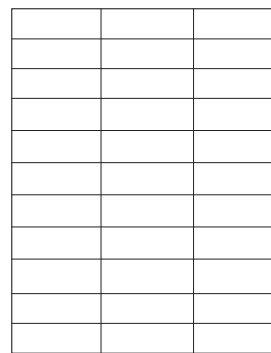

Label Size - 2-27/32 x 1

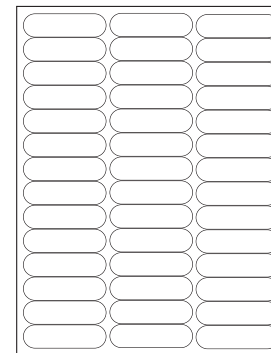

Label Size - 2-5/8 x 3/4

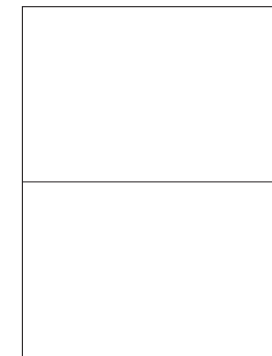

Label Size - 8-1/2 x 5-1/2

*Registered trademark of the Avery Corporation

Integrated Sheets

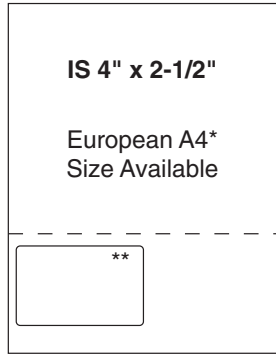

1up - 4 x 2-1/2 Label

- Label is 7/8 from bottom and 1/4 from left with perf at 3-3/4
- * 210mm x 297mm
- ** 102mm x 64mm

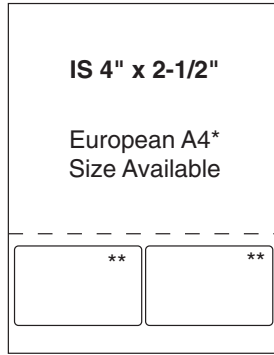

2up - 4 x 2-1/2 Label

- Labels are 3/16 from left & right, 7/8 from bottom, 1/8 between labels with perf at 3-3/4
- * 210mm x 297mm
- ** 102mm x 64mm



1up - 8 x 3-1/2 Label

- Label is 1/4 from left & right and 7/8 from bottom
- * 210mm x 297mm
- ** 202mm x 89mm

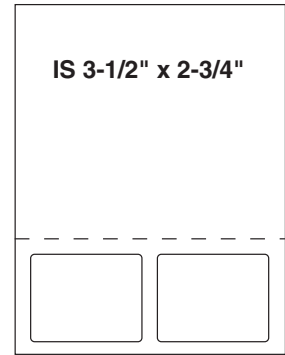

2up - 3-1/2 x 2-3/4 Labels

- Labels are 1/2 from left & right, 3/8 from bottom, with 1/2 between labels and perf at 3-5/8

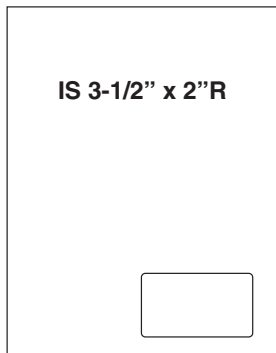

1up - 3-1/2 x 2 Label

- Label is 3/4 from right and 5/8 from bottom

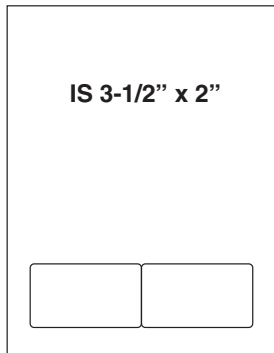

2up - 3-1/2 x 2 Labels

- Labels are 3/4 from left & right, 7/8 from bottom with no space between labels

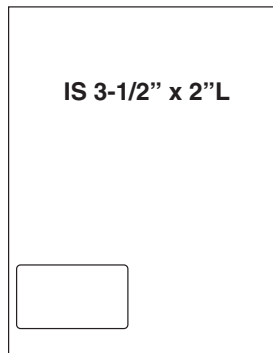

1up - 3-1/2 x 2 Label

- Label is 1/4 from left and 7/8 from bottom

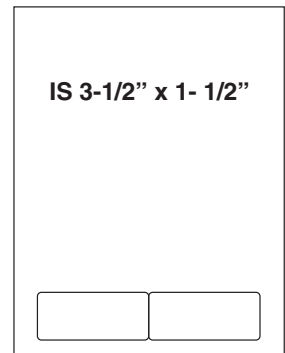

2up - 3-1/2 x 1-1/2 Label

- Labels are 1/2 from bottom and 3/4 from left & right with no space between labels

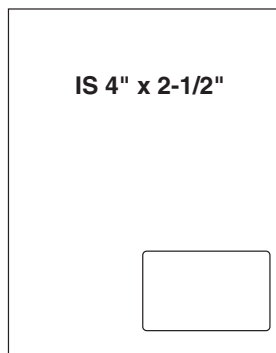

1up - 4 x 2-1/2 Label

- Label is 7/8 from bottom and 1/4 from right

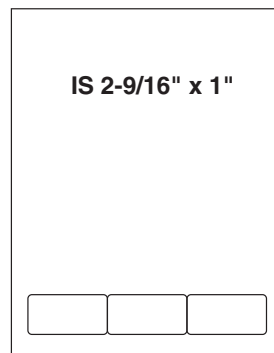

2-9/16 x 1 - 3 Across

- Labels are 3/8 from right & left and 3/8 from bottom

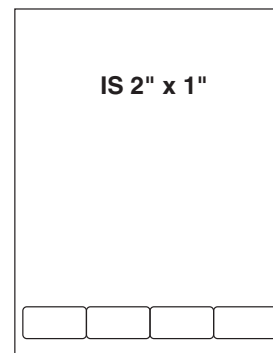

2 x 1 - 4 Across

- Labels are 1/4 from right & left and 5/8 from bottom

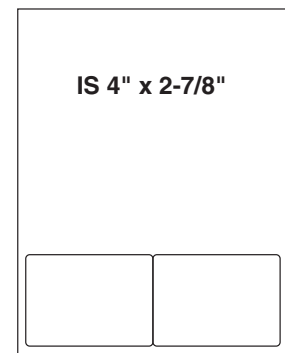

2up - 4 x 2-7/8

- Labels are 1/4 from right & left and 3/8 from bottom, with no space between label

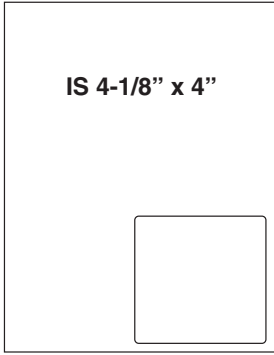

1up - 4-1/8 x 4 Label
 • Label is 1/4 from bottom and 1/4 from right

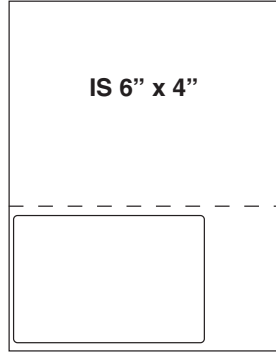

1up - 6 x 4 Label
 • Label is 1/4 from bottom and 1/8 from left and perf at 4-5/8

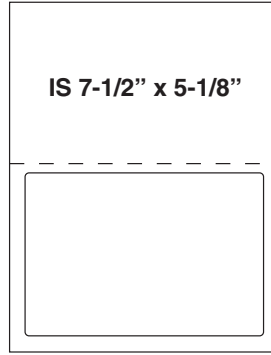

1up - 7-1/2 x 5-1/8 Label
 • Label is 1/2 from left & right and 1/2 from bottom

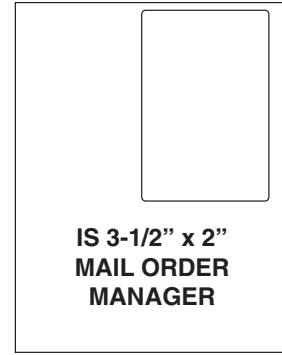

1up - 4 x 6 Label
 • Label is 1/2 from right and 1/4 from top

- Form size 8.5 x 11
- 24# Laser bond
- 1500 sheets per box
- Also available in 14"

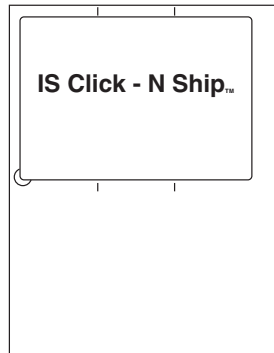

Work With US Post
 Office Web Site
 Click-N-Ship™.com
 U.S. Post Office

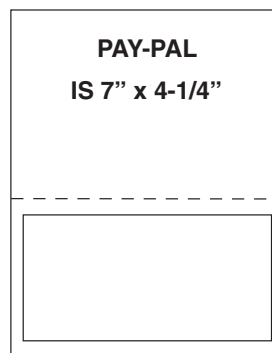

1 up 7 x 4-1/4 Label
 • Label is centered left to right and 1" from bottom perf at 6

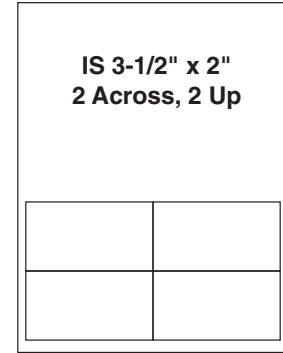

3-1/2 x 2 - 2 Across, 2up
 • Labels are 3/8 from bottom & 3/4 from right & left with no space between labels

Thermal Transfer Labels / Direct Thermal

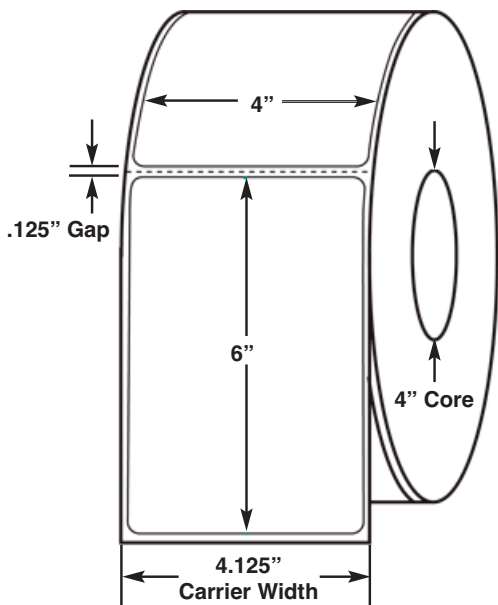

General use label with Perforation

- 1000 labels per roll
- 4 rolls per carton
- Label size: 4" x 6"
- Carrier size: 4.125" x 6.125"
- White paper stock
- 3 inch Core
- Adhesive permanent
- Labels wound out

PERF OUT CARD



Integrated Cards
 1up - 3-3/8 x 2-1/8
 7 point matte stock

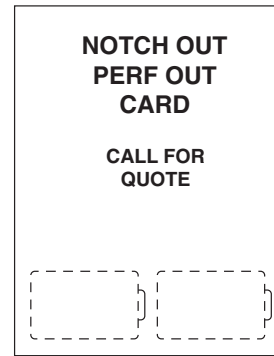

Integrated Cards
 2up - 3-3/8 x 2-1/8
 7 point matte stock

DUAL WEBS / LABEL FORMS

PHARMACY FORMS

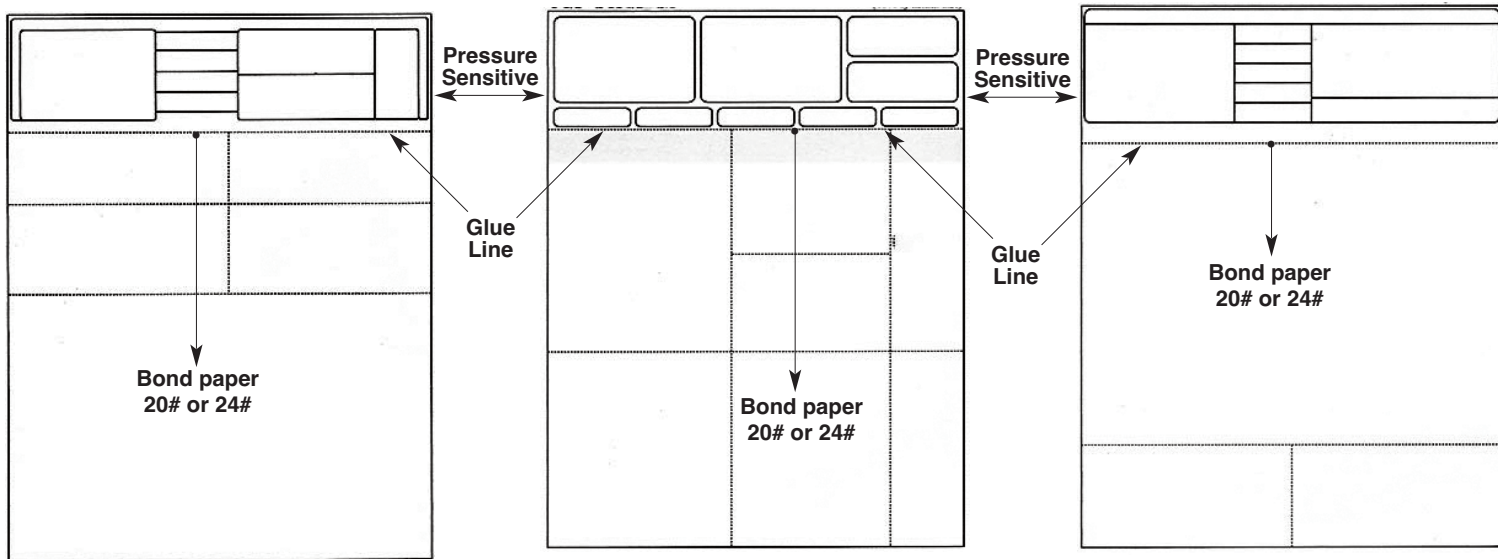

- Computer Paper
- Jumbo Laser Rolls
- Laser Cut Sheets
- Pads
- Wide Format Media
- Pre-Collated Sheets

- Retail Rolls
- Carbonless Forms
- Envelopes
- Copy Paper
- Snap Sets
- Norand Forms

Logistic Services:

- End to End Fulfillment
- Warehousing & Distribution
- Third Party Logistics
- Local cartage & Long haul



Products